



*Effortless hurricane protection for your home.*

*WinGuard® Vinyl Products*

**P&T** WinGuard®



## PIONEER OF IMPACT-RESISTANT TECHNOLOGY

In business over 25 years, PGT® is a leading manufacturer of custom windows and doors—and sells more residential impact-resistant products than anyone else. Choose PGT and expect quality without compromise in selection, service and satisfaction.

Your home. It's your refuge, your sanctuary, the place you and your family feel safest. It's the reason you need PGT® WinGuard® Impact-Resistant Windows and Doors.

WinGuard® products meet the most stringent code requirements for hurricane-force winds and flying debris, to ensure that even after impact, the glass remains in the frame. But WinGuard does so much more for your home, your family and your belongings. Providing year-round security against thieves and intruders. Dramatically reducing outdoor noise. Filtering out 99% of the UV light that enters your home causing fading. And our laminated insulating glass improves energy efficiency, which significantly reduces cooling and heating costs. It's continuous, overall protection – without having to think twice.

SAFEGUARD  
YOUR HOME,  
WITHOUT  
LIFTING  
A FINGER.

*"After 25 years of boarding up my home during storm threats, I was thrilled to learn that a product like WinGuard existed in the industry. You can be sure that my next home will use WinGuard and that we will encourage and specify PGT in our custom and spec homes. The WinGuard product immediately sets a beach house apart."*

Mickey Hayes, President  
Kitty Hawk Land Development  
Kitty Hawk, NC

Kitty Hawk Land Development;  
Kitty Hawk and Corolla, NC

ENGINEERED  
TO MEET  
HURRICANES  
HEAD-ON.



*When flying debris pierces regular windows or doors, internal air pressure can cause the roof to blow off, resulting in wind and water damage.*



AUGUST 1992. MIAMI, FLORIDA. HURRICANE ANDREW. CATEGORY FIVE. This catastrophic storm taught researchers that violent winds alone are not the major cause of window failure and the devastation that follows. More significant is the impact of flying objects. This discovery changed hurricane codes forever. Codes now focus on impact protection for windows and doors in addition to the ability to withstand high wind velocities. PGT® was the first to offer a complete line of residential impact-resistant windows and doors ten years ago and helped develop the testing protocols still used today.

Our exclusive vinyl windows and doors combine heavy-duty frames with impact-resistant laminated glass to ensure nothing unwarranted invades your home in the event of a major storm. A special silicone glazing process is used to keep the glass from breaking away from its frame. Although wind-borne debris may crack the glass on impact, the interlayer keeps the overall window intact, preventing destructive winds from entering your home.



## VINYL FRAME

*Impact-resistant glass is comprised of two panes of glass bonded together with a special interlayer of clear polyvinylbutyral. A combination of this glass and vinyl frames provides amazing protection from flying debris and high winds. Standard insulating glass provides enhanced energy efficiency.*

PGT's complete line of WinGuard® with vinyl frames products meet or exceed International Building Code standards for air/water/structural and small and large impact protection. They are all tested to AAMA/NWWDA 101/I.S. 2-97 specifications and ASTM E1886/E1996 large missile protocols. The single hung and picture window have Miami-Dade NOAs and pass TAS 201, 202 and 203 for air, water, structural, and both small and large missile protection.

What does all this mean to you and your home? WinGuard can withstand blow after blow by a nine-pound, 2 x 4 beam traveling at 34 miles per hour, followed by hurricane-force winds and the glass will still remain in its frame.

*Should the impact-resistant glass crack on contact, the durable interlayer keeps the window intact and in place.*

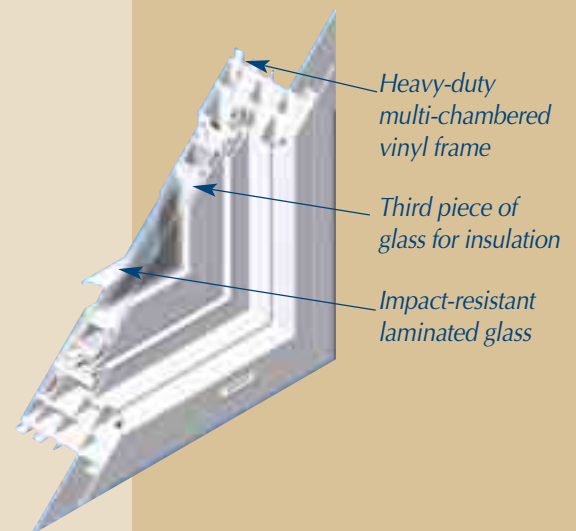

# MORE THAN JUST HURRICANE PROTECTION.

## LIKE SUNSCREEN FOR YOUR HOME.

By filtering out 99% of UV rays, WinGuard® helps shield your furniture, carpet, artwork and drapes from the effects of fading caused by the sun. We also offer a variety of high-performance glass options, which feature tints and Low-E coatings that reduce solar heat gain, increase comfort and help you better manage energy costs. There are many ENERGY STAR® qualified window and door configurations available.

## TAX CREDIT ELIGIBLE PRODUCTS

WinGuard® Vinyl Series 500 Single Hung, Horizontal Roller, Casement and Picture/Architectural Windows qualify for the government's energy tax credits in the American Recovery and Reinvestment Act of 2009.

The Act includes an incentive for homeowners across America to receive a 30% tax credit (up to \$1,500) per household for energy efficient home improvements made in 2009 and 2010.



*Kitty Hawk Land Development;  
Kitty Hawk and Corolla, NC*



*"We have a model home with WinGuard windows and doors that sits right on a busy highway. Everyone that enters the home is just amazed at how quiet they make the house. They go crazy over them!"*

*Our energy bills have also been below the other model homes that we have without WinGuard windows."*

Doug Bradford,  
Construction Manager  
Kitty Hawk Land Company  
Kitty Hawk, Inc.

## PROTECTION BEYOND MOTHER NATURE.

Breaking a window is the most common means of entry for an intruder. But with WinGuard®, the same effortless protection that guards against hurricane damage also deters intruders. While normal windows shatter easily upon contact, the durability of WinGuard keeps windows in one piece. Whether it be a major storm or an attempted break in, WinGuard helps keep you, your family and your home safe 24 hours a day, 365 days a year.

## SAFE AND SOUND.

The laminated glass in PGT® WinGuard® Impact-Resistant Windows and Doors absorbs sound rather than transmitting it, which helps to keep the world and its disruptions outside where they belong. In fact, the same type of glass is often used in airports and recording studios to significantly reduce ambient noise.



PROTECT  
YOUR HOME  
IN EVERY WAY.

*"I wish I could have seen the point where they threw up their hands and said, 'The heck with this house. I'm never coming back,' " said Martha Thomas, who was arriving home when she and her husband discovered several windows and doors had been battered by would-be burglars using a propane gas tank, a concrete pillar and even a crow bar.*

*"I was mad and angry that somebody tried to break in, but when I realized they did not gain entry into my house, I was elated!"*

Martha Thomas  
Palm Beach County, FL

THE EFFORTLESS  
WAY TO  
PROTECT YOUR  
HOME – AND ITS  
APPEARANCE.



### **THERE'S NO PLACE LIKE YOUR HOME.**

WinGuard® does more than beautify your home; it protects without the hassle and expense of unsightly storm panels and hurricane shutters. It truly is the all-in-one solution for continuous, effortless protection from hurricanes, intruders, outside noise and damaging sunlight. Even when you're away.

Be sure to ask your insurance provider if you qualify for discounts by making WinGuard® Impact-Resistant Windows and Doors your choice for hurricane protection.

### **THE BEST FROM AN INDUSTRY LEADER.**

Offering impact-resistant products since 1996, PGT® has become a leading authority on hurricane protection. PGT® WinGuard® is the most popular impact-resistant window with over one million units installed. Each WinGuard window and door is custom-made in our manufacturing facility and glass plant, then delivered by our fleet of trucks. PGT's dedication to customer satisfaction is proven in our on-time delivery record, quality product line and unparalleled customer service.





*Don't spend time, energy or money installing shutters every time a storm threatens your home.*



*Unattractive roll-down and accordion-style shutters offer no protection if you're not home to close them every time a storm threatens.*

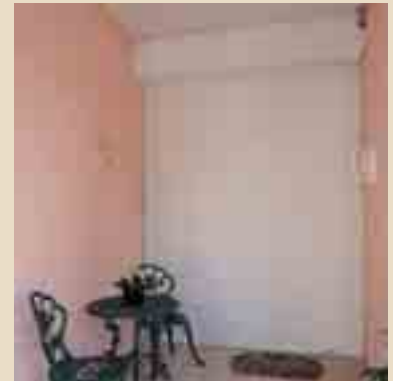

*Think about how much valuable storage space is wasted with panel shutters or plywood sheets when they're not in use.*



## ASCE WIND ZONE MAP

Areas subject to hurricane-force winds

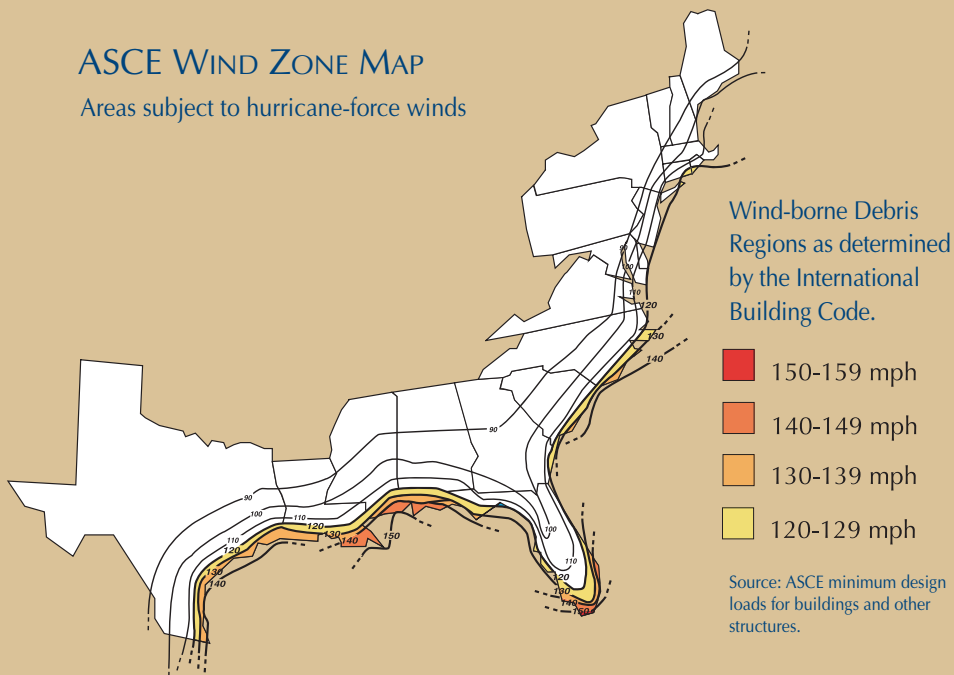

# VINYL FRAMES

## GENERAL SPECIFICATIONS

### COMPLETE PRODUCT LINE

- Double Hung Windows
- Single Hung Windows
- Horizontal Roller Windows
- Casement Windows
- Picture Windows/Fixed Lite Architectural Windows
- Sliding Glass Doors
- French Doors
- Mull Bars and Mull Clips

### PERFORMANCE TESTING

- Single Hung and Picture Window tested to Miami-Dade protocols and qualify as large and small missile
- Passes ASTM E1886/E1996 (Missile Class D) for large missile impact resistance
- Meets or exceeds all AAMA/NWWDA 101/I.S.2-97 specifications
- Passes ASTM E987 for deglazing
- Passes ASTM E547/E331 for water resistance
- Passes ASTM E283 for air infiltration
- Operable windows pass AAMA 1302.5 and doors pass AAMA 1303.5 for forced entry resistance
- NFRC Certified
- Energy Star qualified configurations

### FRAMES

- Reinforced heavy-duty vinyl frame
- Frame depth is 3<sup>1</sup>/<sub>4</sub>" for windows and 5<sup>15</sup>/<sub>16</sub>" for doors
- Equal leg frame for replacement
- Integral J-channel for siding
- Integral flange for masonry construction
- Integral nail-fin frame for wood frame construction

### GLAZING

- All products are exterior glazed
- All products are silicone glazed for greater strength and seal

### WEATHERSTRIPPING

- Fully weatherstripped with fin seal polyester pile

### SCREENS

- Window screens are fitted at time of assembly to ensure a complete unit
- 18 x 16 fiberglass mesh
- Insect screens are not designed for the purpose of providing security and will not protect objects or persons from falling out of windows

WinGuard® Impact-Resistant Windows and Doors offer a wide variety of design options to enhance the style, beauty and comfort of your home. And our vinyl frames provide low-maintenance, long-lasting beauty.

## DISTINCTIVE STYLING FOR YOUR HOME.

### FRAME COLORS

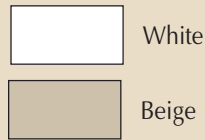

### WINDOW AND DOOR STYLES

- Double Hung Windows
- Single Hung Windows
- Horizontal Roller Windows
- Casement Windows
- Picture Windows/  
Fixed Lite Architectural  
Windows
- Sliding Glass Doors
- French Doors

### DESIGN OPTIONS

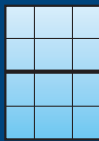

COLONIAL



PRAIRIE/BRITTANY  
6-LITE

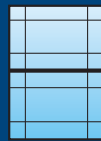

PRAIRIE/BRITTANY  
9-LITE (CUSTOM)

Muntin styles depicted are on a Single Hung Window.  
Muntins will vary depending on the window style and size.



### GLASS

- Impact-Resistant Laminated insulating glass standard

### GLASS TINTS

- Clear
- Gray
- Green
- Bronze
- Obscure (Textured glass for enhanced privacy)
- Low-E

### MUNTIN OPTIONS

- 13/16" colonial insulating grids between glass
- Basic simulated divided lite – 1" ogee muntin on the exterior with flat muntin on the interior
- Classic simulated divided lite – 1" ogee muntin on the exterior, flat muntin on the interior and 13/16" grids between glass



*"During the past year it was such a relief to know we didn't have to worry about putting up shutters whenever there was a hurricane warning."*

Phil and Ilene Barocas  
Ft. Lauderdale, FL



All WinGuard products are NFRC certified.

# VINYL FRAMES

## DOUBLE HUNG – SERIES DH560

- 3 1/4" frame depth
- Frame Options:
  - 5/8" extruded flange
  - 1 5/8" integral nail fin
  - J-channel
  - Equal leg
- Reinforced frame corner construction
- Frame and sash corners are welded mitered joints
- Fully-reinforced tilt-sash design with recessed tilt-sash latches
- Removable full screen
- Pro-View (Oriel style) option is available

*NOTE: WinGuard® brand refers only to those products that are glazed with PGT® laminated glass.*

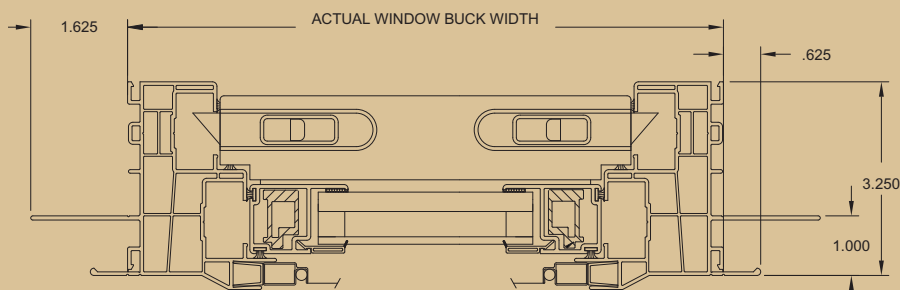
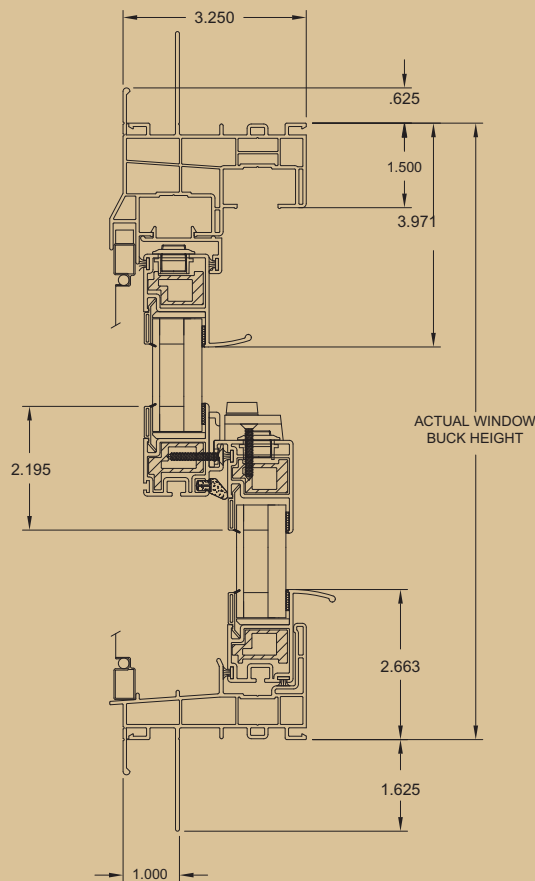

### DESIGN PRESSURE GUIDE

STYLE	TESTED PRESSURE	WATER-TESTED PRESSURE	TESTED SIZE	TYPE OF TEST	RATING
Double Hung	+50 psf	7.5 psf	52 1/8" x 75"	ANSI/AAMA/WDMA 101/I.S.2/NAFS and ASTM E1886/E1996	H-R50

# VINYL FRAMES

## SINGLE HUNG – SERIES SH500

- 3 1/4" frame depth
- Frame Options:
  - 5/8" flange
  - 1 5/8" integral nail fin
  - J-channel
  - Equal leg
- Reinforced frame corner construction
- Frame and sash corners are welded mitered joints
- Fully-reinforced tilt-sash design with lockable tilt-sash latches
- Locking hardware is deluxe swivel type
- Removable half-screen
- Pro-View (Oriel style) option is available

*NOTE: WinGuard® brand refers only to those products that are glazed with PGT® laminated glass.*

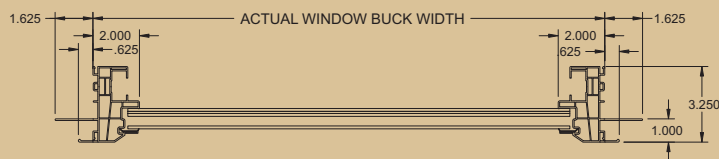
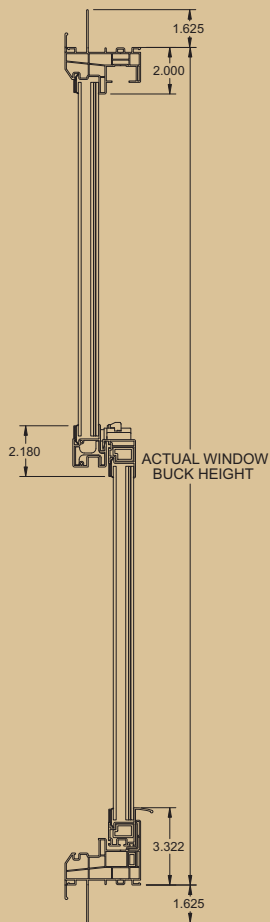
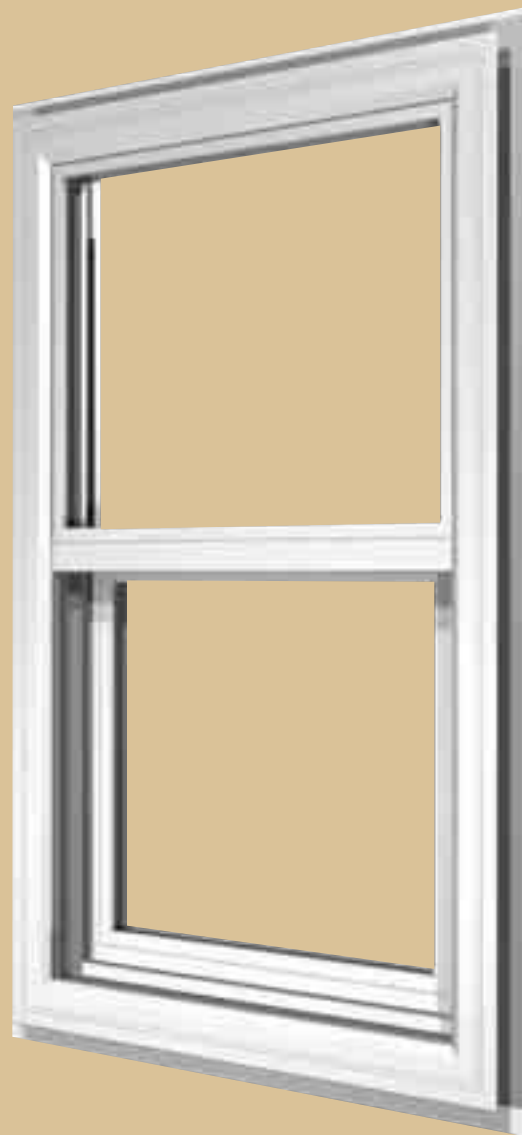











































### DESIGN PRESSURE GUIDE

STYLE	TESTED PRESSURE	WATER-TESTED PRESSURE	TESTED SIZE	TYPE OF TEST	RATING
Single Hung	+60/-70 psf	9.0 psf	52 1/8" x 75"	AAMA/NWWDA 101/I.S.2-97 and ASTM E1886/E1996 Miami-Dade Protocols TAS 201, 202 203	H-R60





# SINGLE HUNG – SERIES SH500 DOUBLE HUNG – SERIES DH560

## SIZE CHART & STANDARD COLONIAL CONFIGURATIONS

			COMMODITY				MODULAR				
ACTUAL WINDOW HEIGHT	MASONRY OPENING*	WOOD FRAME OPENING	18 <sup>1</sup> / <sub>8</sub>	25 <sup>1</sup> / <sub>2</sub>	36	52 <sup>1</sup> / <sub>8</sub>	23	31	39	43	47
25	26	25 <sup>1</sup> / <sub>4</sub>	 12	 H32	 22	 32	 2022	 2822	 3422	 3822	 4022
37 <sup>3</sup> / <sub>8</sub>	38 <sup>3</sup> / <sub>8</sub>	37 <sup>5</sup> / <sub>8</sub>	 13	 H33	 23	 33	 2033	 2833	 3433	 3833	 4033
49 <sup>5</sup> / <sub>8</sub>	50 <sup>5</sup> / <sub>8</sub>	49 <sup>7</sup> / <sub>8</sub>	 14	 H34	 24	 34	 2043	 2843	 3443	 3843	 4043
62	63	62 <sup>1</sup> / <sub>4</sub>	 15	 H35	 25	 35	 2053	 2853	 3453	 3853	 4053
75	76	75 <sup>1</sup> / <sub>4</sub>	 16	 H36	 26		 2064	 2864	 3464	 3864	

\*Note: Openings calculated using 1/8" shim space (maximum 1/4" allowed), 1x bucks and pre-cast sills. If using poured sills add 3/4". Framing dimensions are calculated with drywall butted.

### Egress availability

-  Egress opening is 5.7 square feet or greater
-  Egress opening is 5.7 square feet or greater (applies to double hung only)
-  Egress opening is between 5.0 and 5.699 square feet
-  Egress opening is between 5.0 and 5.699 square feet (applies to double hung only)

# SIZE CHART & STANDARD COLONIAL CONFIGURATIONS

## NOMINAL

ACTUAL WINDOW WIDTH	17 <sup>1</sup> / <sub>2</sub>	19 <sup>1</sup> / <sub>2</sub>	23 <sup>1</sup> / <sub>2</sub>	27 <sup>1</sup> / <sub>2</sub>	29 <sup>1</sup> / <sub>2</sub>	31 <sup>1</sup> / <sub>2</sub>	35 <sup>1</sup> / <sub>2</sub>	39 <sup>1</sup> / <sub>2</sub>	43 <sup>1</sup> / <sub>2</sub>	47 <sup>1</sup> / <sub>2</sub>
MASONRY OPENING*	19 <sup>1</sup> / <sub>4</sub>	21 <sup>1</sup> / <sub>4</sub>	25 <sup>1</sup> / <sub>4</sub>	29 <sup>1</sup> / <sub>4</sub>	31 <sup>1</sup> / <sub>4</sub>	33 <sup>1</sup> / <sub>4</sub>	37 <sup>1</sup> / <sub>4</sub>	41 <sup>1</sup> / <sub>4</sub>	45 <sup>1</sup> / <sub>4</sub>	49 <sup>1</sup> / <sub>4</sub>
WOOD FRAME OPENING	17 <sup>3</sup> / <sub>4</sub>	19 <sup>3</sup> / <sub>4</sub>	23 <sup>3</sup> / <sub>4</sub>	27 <sup>3</sup> / <sub>4</sub>	29 <sup>3</sup> / <sub>4</sub>	31 <sup>3</sup> / <sub>4</sub>	35 <sup>3</sup> / <sub>4</sub>	39 <sup>3</sup> / <sub>4</sub>	43 <sup>3</sup> / <sub>4</sub>	47 <sup>3</sup> / <sub>4</sub>

35 <sup>1</sup> / <sub>2</sub>	36 <sup>1</sup> / <sub>2</sub>	35 <sup>3</sup> / <sub>4</sub>										
			1630**	1830	2030	2430	2630	2830	3030	3430	3830	4030
37 <sup>1</sup> / <sub>2</sub>	38 <sup>1</sup> / <sub>2</sub>	37 <sup>3</sup> / <sub>4</sub>										
			1632**	1832	2032	2432	2632	2832	3032	3432	3832	4032
43 <sup>1</sup> / <sub>2</sub>	44 <sup>1</sup> / <sub>2</sub>	43 <sup>3</sup> / <sub>4</sub>										
			1638**	1838	2038	2438	2638	2838	3038	3438	3838	4038
45 <sup>1</sup> / <sub>2</sub>	46 <sup>1</sup> / <sub>2</sub>	45 <sup>3</sup> / <sub>4</sub>										
			16310**	18310	20310	24310	26310	28310	30310	34310	38310	40310
47 <sup>1</sup> / <sub>2</sub>	48 <sup>1</sup> / <sub>2</sub>	47 <sup>3</sup> / <sub>4</sub>										
			1640**	1840	2040	2440	2640	2840	3040	3440	3840	4040
49 <sup>1</sup> / <sub>2</sub>	50 <sup>1</sup> / <sub>2</sub>	49 <sup>3</sup> / <sub>4</sub>										
			1642**	1842	2042	2442	2642	2842	3042	3442	3842	4042
51 <sup>1</sup> / <sub>2</sub>	52 <sup>1</sup> / <sub>2</sub>	51 <sup>3</sup> / <sub>4</sub>										
			1644**	1844	2044	2444	2644	2844	3044	3444	3844	4044
53 <sup>1</sup> / <sub>2</sub>	54 <sup>1</sup> / <sub>2</sub>	53 <sup>3</sup> / <sub>4</sub>										
			1646**	1846	2046	2446	2646	2846	3046	3446	3846	4046
59 <sup>1</sup> / <sub>2</sub>	60 <sup>1</sup> / <sub>2</sub>	59 <sup>3</sup> / <sub>4</sub>										
			1650**	1850	2050	2450	2650	2850	3050	3450	3850	4050
61 <sup>1</sup> / <sub>2</sub>	62 <sup>1</sup> / <sub>2</sub>	61 <sup>3</sup> / <sub>4</sub>										
			1652**	1852	2052	2452	2652	2852	3052	3452	3852	4052
65 <sup>1</sup> / <sub>2</sub>	66 <sup>1</sup> / <sub>2</sub>	65 <sup>3</sup> / <sub>4</sub>										
			1656**	1856	2056	2456	2656	2856	3056	3456	3856	4056
71 <sup>1</sup> / <sub>2</sub>	72 <sup>1</sup> / <sub>2</sub>	71 <sup>3</sup> / <sub>4</sub>										
			1660**	1860	2060	2460	2660	2860	3060	3460	3860	4060
73 <sup>1</sup> / <sub>2</sub>	74 <sup>1</sup> / <sub>2</sub>	73 <sup>3</sup> / <sub>4</sub>										
			1662**	1862	2062	2462	2662	2862	3062	3462	3862	4062
ACTUAL WINDOW HEIGHT	MASONRY OPENING*	WOOD FRAME OPENING										



\*\*Note: Only available for Single Hung window.

# VINYL FRAMES

## HORIZONTAL ROLLER – SERIES HR510

- 3 1/4" frame depth
- Frame Options:
  - 5/8" flange
  - 1 5/8" integral nail fin
  - J-channel
  - Equal Leg
- Frame and sash corners are welded mitered joints
- XO or OX configurations
- Aluminum reinforced with removable sash design
- Locking hardware is deluxe swivel type
- Brass tandem rollers
- Removable half screen

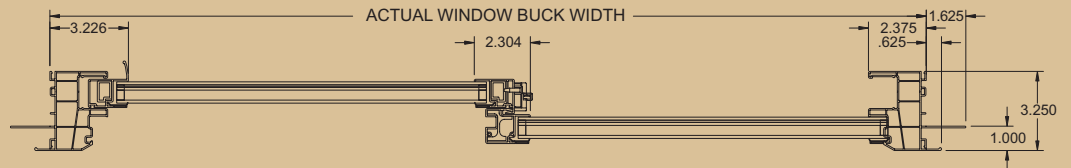
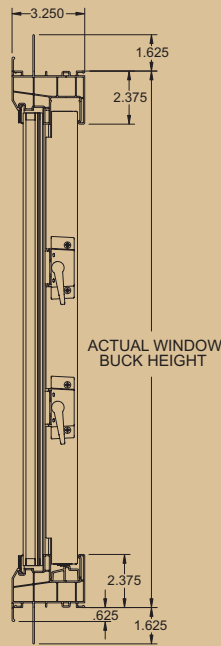

NOTE: WinGuard® brand refers only to those products that are glazed with PGT® laminated glass.

### SIZE CHART & STANDARD COLONIAL CONFIGURATIONS

#### XO or OX

COMMODITY	ACTUAL WINDOW WIDTH	25 1/2	36	52 1/8
	MASONRY OPENING*	27 1/4	37 3/4	53 7/8
	WOOD FRAME OPENING	25 3/4	36 1/4	52 3/8
	25	26	25 1/4	
	37 3/8	38 3/8	37 5/8	
	49 5/8	50 5/8	49 7/8	
ACTUAL WINDOW HEIGHT	MASONRY OPENING*	WOOD FRAME OPENING		

\*Note: Openings calculated using 1/8" shim space (maximum 1/4" allowed), 1x bucks and pre-cast sills. If using poured sills add 3/4". Framing dimensions are calculated with drywall butted.

#### Egress availability

















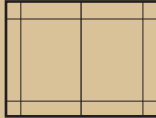











- Egress opening is 5.7 square feet or greater
- Egress opening is between 5.0 and 5.699 square feet



## SIZE CHART & STANDARD COLONIAL CONFIGURATIONS













### XO or OX

#### MODULAR

ACTUAL WINDOW WIDTH		35	47	53	59	65	71	73			
MASONRY OPENING*		36 <sup>3</sup> / <sub>4</sub>	48 <sup>3</sup> / <sub>4</sub>	54 <sup>3</sup> / <sub>4</sub>	60 <sup>3</sup> / <sub>4</sub>	66 <sup>3</sup> / <sub>4</sub>	72 <sup>3</sup> / <sub>4</sub>	74 <sup>3</sup> / <sub>4</sub>			
WOOD FRAME OPENING		35 <sup>1</sup> / <sub>4</sub>	47 <sup>1</sup> / <sub>4</sub>	53 <sup>1</sup> / <sub>4</sub>	59 <sup>1</sup> / <sub>4</sub>	65 <sup>1</sup> / <sub>4</sub>	71 <sup>1</sup> / <sub>4</sub>	73 <sup>1</sup> / <sub>4</sub>			
ACTUAL WINDOW HEIGHT	25	26	25 <sup>1</sup> / <sub>4</sub>	 3022	 4022	 4622	 5022	 5622	 6022	 6222	 Prairie/Brittany 6-lite (standard)
	37 <sup>3</sup> / <sub>8</sub>	38 <sup>3</sup> / <sub>8</sub>	37 <sup>5</sup> / <sub>8</sub>	 3033	 4033	 4633	 5033	 5633	 6033	 6233	
	49 <sup>5</sup> / <sub>8</sub>	50 <sup>5</sup> / <sub>8</sub>	49 <sup>7</sup> / <sub>8</sub>	 3043	 4043	 4643	 5043	 5643	 6043	 6243	
	54	55	54 <sup>1</sup> / <sub>4</sub>	 3046	 4046	 4646	 5046	 5646	 6046	 6246	
				<p><i>*Note: Openings calculated using 1/8" shim space (maximum 1/4" allowed), 1x bucks and pre-cast sills. If using poured sills add 3/4". Framing dimensions are calculated with drywall butted.</i></p>							

#### NOMINAL

ACTUAL WINDOW WIDTH		35 <sup>1</sup> / <sub>2</sub>	47 <sup>1</sup> / <sub>2</sub>	59 <sup>1</sup> / <sub>2</sub>	71 <sup>1</sup> / <sub>2</sub>
MASONRY OPENING*		37 <sup>1</sup> / <sub>4</sub>	49 <sup>1</sup> / <sub>4</sub>	61 <sup>1</sup> / <sub>4</sub>	73 <sup>1</sup> / <sub>4</sub>
WOOD FRAME OPENING		35 <sup>3</sup> / <sub>4</sub>	47 <sup>3</sup> / <sub>4</sub>	59 <sup>3</sup> / <sub>4</sub>	71 <sup>3</sup> / <sub>4</sub>

ACTUAL WINDOW HEIGHT	23 <sup>1</sup> / <sub>2</sub>	24 <sup>1</sup> / <sub>2</sub>	23 <sup>3</sup> / <sub>4</sub>	 3020	 4020	 5020	 6020
	35 <sup>1</sup> / <sub>2</sub>	36 <sup>1</sup> / <sub>2</sub>	35 <sup>3</sup> / <sub>4</sub>	 3030	 4030	 5030	 6030
	47 <sup>1</sup> / <sub>2</sub>	48 <sup>1</sup> / <sub>2</sub>	47 <sup>3</sup> / <sub>4</sub>	 3040	 4040	 5040	 6040
<h3>DESIGN PRESSURE GUIDE</h3>							
	STYLE	TESTED PRESSURE	WATER-TESTED PRESSURE	TESTED SIZE	TYPE OF TEST	RATING	
	Horizontal Roller XO or OX	+60/-70 psf	9.0 psf	73" x 54"	AAMA/NWWDA 101/I.S.2-97 and ASTM E1886/E1996	HS-C60	

# VINYL FRAMES

## CASEMENT – SERIES CA540

- 3 1/4" frame depth
- Frame Options:
  - 5/8" flange
  - 1 5/8" integral nail fin
  - J-channel
  - Equal Leg
- Frame and sash corners are welded mitered joints
- X and O configuration
- Window is beveled exterior face design
- Removable full screen
- Washable hinge standard

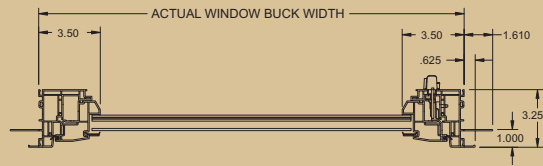
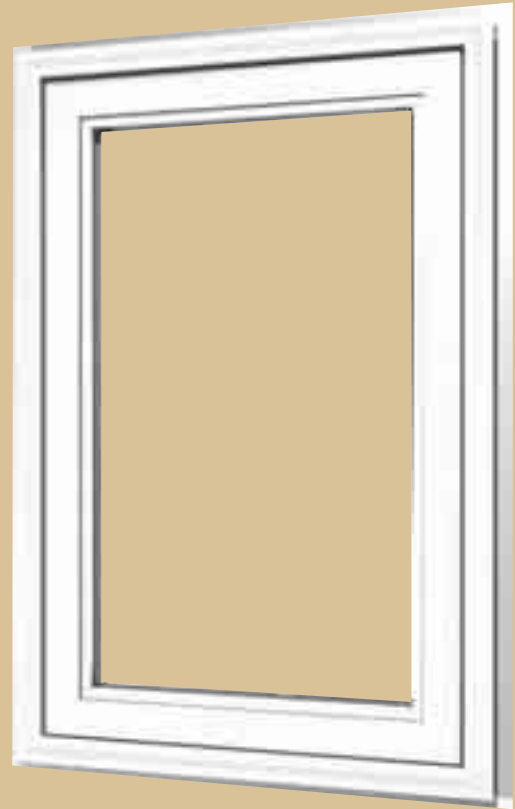
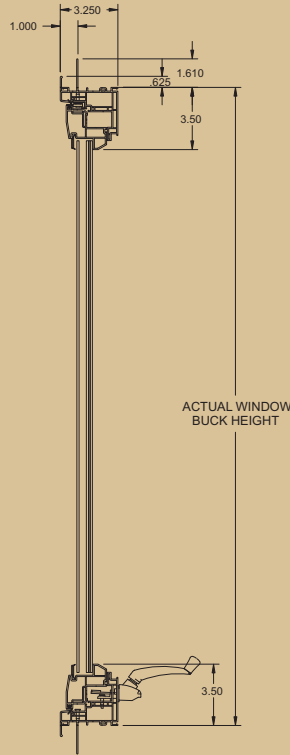

NOTE: WinGuard® brand refers only to those products that are glazed with PGT® laminated glass.

### SIZE CHART & STANDARD COLONIAL CONFIGURATIONS

#### COMMODITY

ACTUAL WINDOW WIDTH	18 1/8	25 1/2	36
MASONRY OPENING*	19 7/8	27 1/4	37 3/4
WOOD FRAME OPENING	18 3/8	25 3/4	36 1/4

















25	26	25 1/4			
37 3/8	38 3/8	37 5/8			
49 5/8	50 5/8	49 1/8			
62	63	62 1/4			
ACTUAL WINDOW HEIGHT	MASONRY OPENING*	WOOD FRAME OPENING	12	H32	22
			13	H33	23
			14	H34	24
			15	H35	25

#### Egress availability

- Egress opening is 5.7 square feet or greater
- Egress opening is between 5.0 and 5.699 square feet































## SIZE CHART & STANDARD COLONIAL CONFIGURATIONS

### MODULAR

			ACTUAL WINDOW WIDTH	23	27	31	
			MASONRY OPENING*	24 <sup>3</sup> / <sub>4</sub>	28 <sup>3</sup> / <sub>4</sub>	32 <sup>3</sup> / <sub>4</sub>	
			WOOD FRAME OPENING	23 <sup>1</sup> / <sub>4</sub>	27 <sup>1</sup> / <sub>4</sub>	31 <sup>1</sup> / <sub>4</sub>	
25	26	25 <sup>1</sup> / <sub>4</sub>					 <p>Prairie/Brittany 9-lite (standard)</p>
			2022	2422	2822		
37 <sup>3</sup> / <sub>8</sub>	38 <sup>3</sup> / <sub>8</sub>	37 <sup>5</sup> / <sub>8</sub>					
			2033	2433	2833		
49 <sup>5</sup> / <sub>8</sub>	50 <sup>5</sup> / <sub>8</sub>	49 <sup>7</sup> / <sub>8</sub>					
			2043	2443	2843		
54	55	54 <sup>1</sup> / <sub>4</sub>					
			2046	2446	2846		
62	63	62 <sup>1</sup> / <sub>4</sub>					
			2053	2453	2853		

*\*Note: Openings calculated using 1/8" shim space (maximum 1/4" allowed), 1x bucks and pre-cast sills. If using poured sills add 3/4". Framing dimensions are calculated with drywall butted.*

### NOMINAL

			ACTUAL WINDOW WIDTH	19 <sup>1</sup> / <sub>2</sub>	23 <sup>1</sup> / <sub>2</sub>	27 <sup>1</sup> / <sub>2</sub>	29 <sup>1</sup> / <sub>2</sub>	35 <sup>1</sup> / <sub>2</sub>
			MASONRY OPENING*	21 <sup>1</sup> / <sub>4</sub>	25 <sup>1</sup> / <sub>4</sub>	29 <sup>1</sup> / <sub>4</sub>	31 <sup>1</sup> / <sub>4</sub>	37 <sup>1</sup> / <sub>4</sub>
			WOOD FRAME OPENING	19 <sup>3</sup> / <sub>4</sub>	23 <sup>3</sup> / <sub>4</sub>	27 <sup>3</sup> / <sub>4</sub>	29 <sup>3</sup> / <sub>4</sub>	35 <sup>3</sup> / <sub>4</sub>
23 <sup>1</sup> / <sub>2</sub>	24 <sup>1</sup> / <sub>2</sub>	23 <sup>3</sup> / <sub>4</sub>						
			1820	2020	2420	2620	3020	
31 <sup>1</sup> / <sub>2</sub>	32 <sup>1</sup> / <sub>2</sub>	31 <sup>3</sup> / <sub>4</sub>						
			1828	2028	2428	2628	3028	
35 <sup>1</sup> / <sub>2</sub>	36 <sup>1</sup> / <sub>2</sub>	35 <sup>3</sup> / <sub>4</sub>						
			1830	2030	2430	2630	3030	
39 <sup>1</sup> / <sub>2</sub>	40 <sup>1</sup> / <sub>2</sub>	39 <sup>3</sup> / <sub>4</sub>						
			1834	2034	2434	2634	3034	
47 <sup>1</sup> / <sub>2</sub>	48 <sup>1</sup> / <sub>2</sub>	47 <sup>3</sup> / <sub>4</sub>						
			1840	2040	2440	2640	3040	
59 <sup>1</sup> / <sub>2</sub>	60 <sup>1</sup> / <sub>2</sub>	59 <sup>3</sup> / <sub>4</sub>						
			1850	2050	2450	2650	3050	

### DESIGN PRESSURE GUIDE

STYLE	TESTED PRESSURE	WATER-TESTED PRESSURE	TESTED SIZE	TYPE OF TEST	RATING
Casement X	+60/-65 psf	10.5 psf	36" x 72"	AAMA/NWWDA 101/I.S.2-97 and ASTM E1886/E1996	C-C60
Casement Fixed	+60/-65 psf	9 psf	72" x 72"	ANSI/AAMA/WDMA 101/I.S.2/NAFS and ASTM E1886/E1996	F-HC60

# VINYL FRAMES

## PICTURE/FIXED LITE ARCHITECTURAL – SERIES PW520/AR520

- 3¼" frame depth
- Frame Options:
  - 5⁄8" flange
  - 1⁵⁄₈" integral nail fin
  - J-channel
  - Equal leg
- Frame corners are welded mitered joints
- Snap-on cover conceals screw heads
- Standard shapes include picture, arch, oval, full circle, half circle, fan, quarter circle, elliptical, eyebrow, hexagon, octagon, triangle, pentagon and trapezoid



*NOTE: WinGuard® brand refers only to those products that are glazed with PGT® laminated glass.*

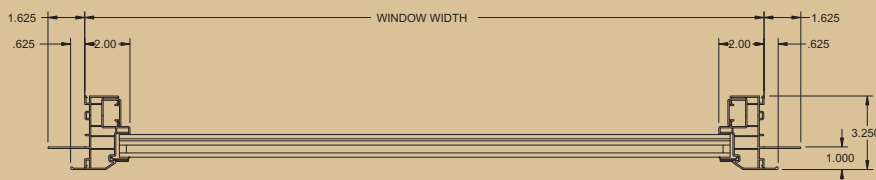

## STANDARD SHAPES



HALF CIRCLE



FAN



EYEBROW

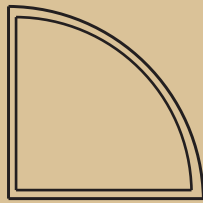

QUARTER CIRCLE

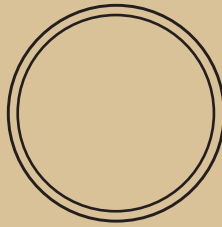

CIRCLE

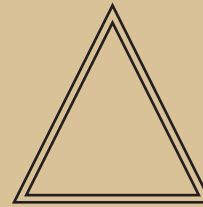

TRIANGLE

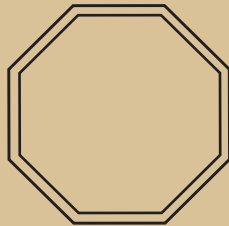

OCTAGON

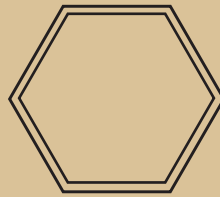

HEXAGON

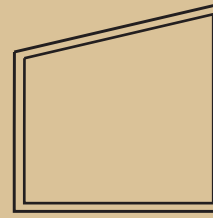

TRAPEZOID



ELLIPTICAL

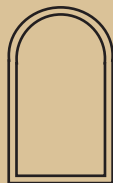

ARCH

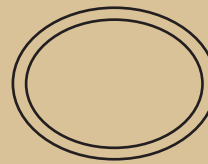

OVAL

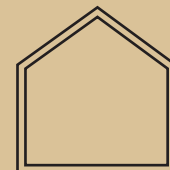

PEAK PENTAGON

### DESIGN PRESSURE GUIDE

STYLE	TESTED PRESSURE	WATER-TESTED PRESSURE	TESTED SIZE	TYPE OF TEST	RATING
Fixed Lite	+/-80 psf	16.8 psf	96" x 60"	AAMA/NWWDA 101/I.S.2-97 and ASTM E1886/E1996	F-C80
PW	+/-80 psf	15.0 psf	48" x 62"	Miami-Dade Protocols TAS 201, 202 203	
Half Circle	+/-80 psf	15.0 psf	63" x 31 1/2"	Miami-Dade Protocols TAS 201, 202 203	

# VINYL FRAMES

## SLIDING GLASS DOORS – SERIES SGD530

- 5<sup>15</sup>/<sub>16</sub>" frame depth
- Frame Options:  
Integral nail fin  
Equal leg
- Aluminum reinforced vinyl panels
- Panel corners are welded mitered joints
- Locking hardware is deluxe mortise type with key lock
- Adjustable, stainless steel ball bearing tandem roller system for smoother operation
- Fully weatherstripped, deep integral panel interlocks and door frame provide a tighter seal against wind and water
- XO or OX configurations

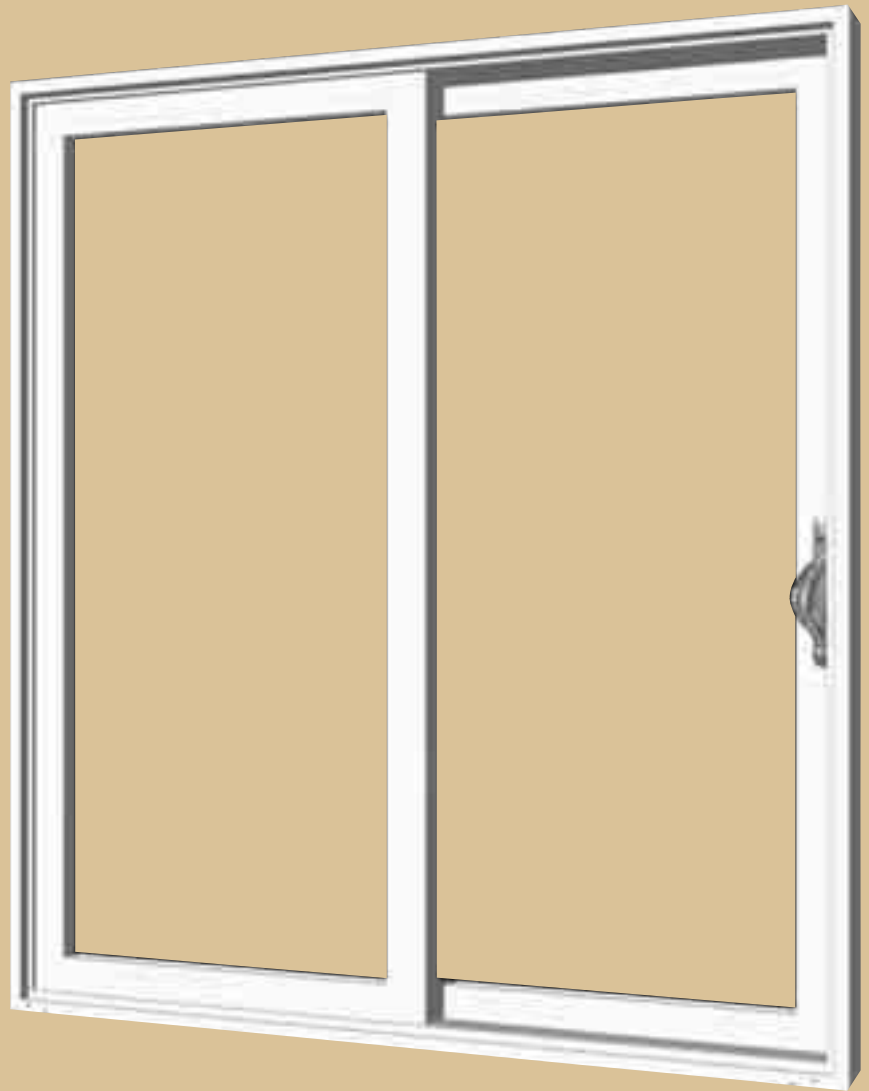

*NOTE: WinGuard® brand refers only to those products that are glazed with PGT® laminated glass.*

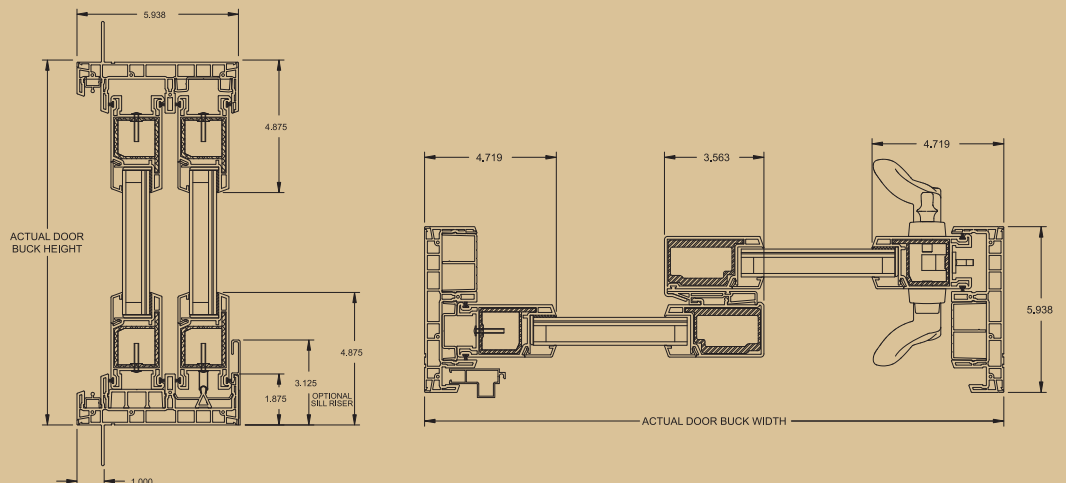

## SIZE CHART & STANDARD COLONIAL CONFIGURATIONS

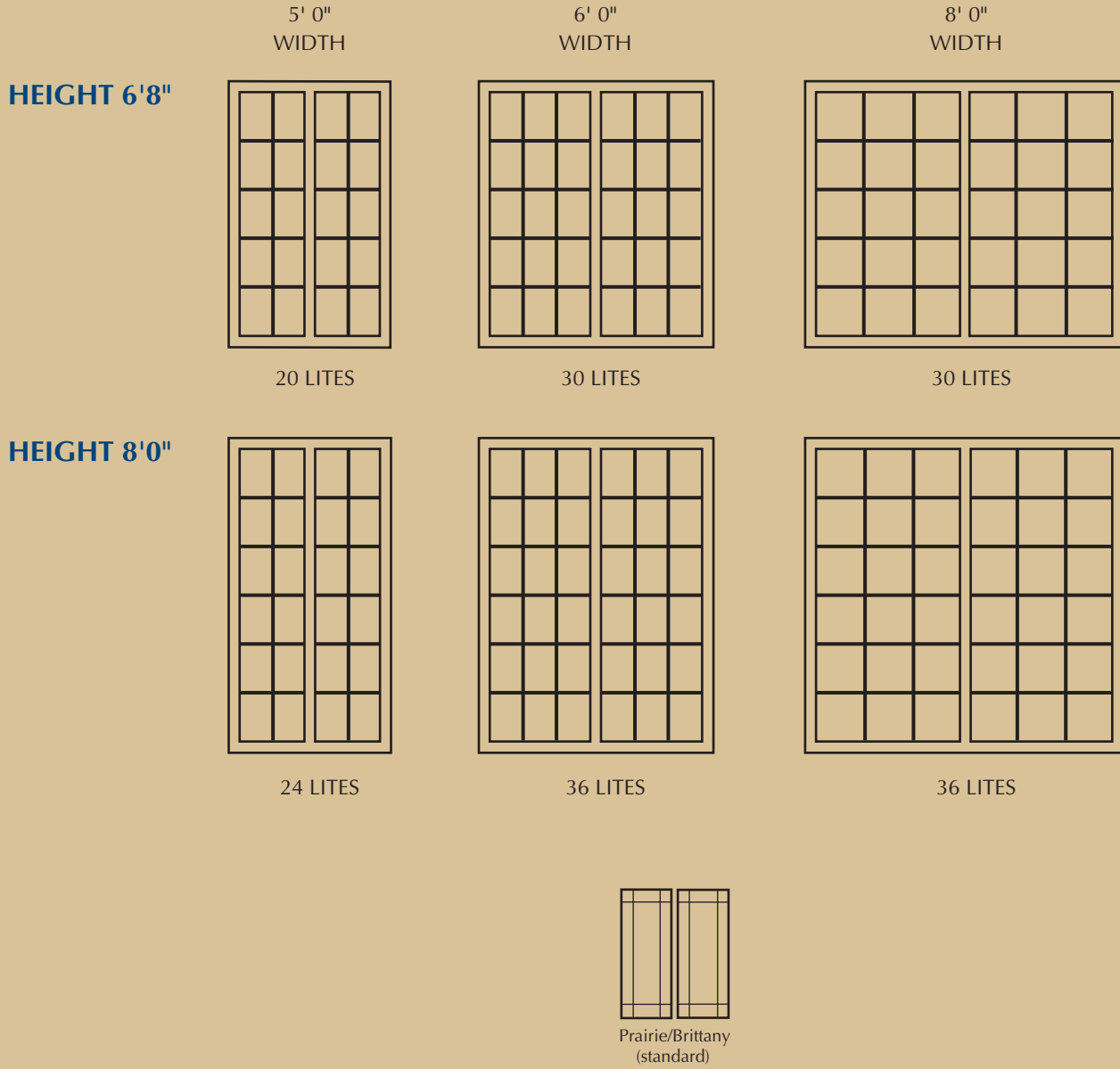

### DESIGN PRESSURE GUIDE

STYLE	TESTED PRESSURE	WATER-TESTED PRESSURE	TESTED SIZE	TYPE OF TEST	RATING
Sliding Glass Door (XO, OX)	+60/-70 psf	Standard Sill 6 psf High Rise Sill 9 psf	95 1/2" x 95 1/2"	AAMA/NWWDA 101/I.S.2-97 and ASTM E1886/E1996	SGD-C60

# VINYL FRAMES

## FRENCH DOOR - SERIES FD550

- 5<sup>5</sup>/<sub>8</sub>" frame depth
- Frame Options:
  - 1<sup>1</sup>/<sub>8</sub>" integral nail fin
  - Equal leg
- 2<sup>9</sup>/<sub>16</sub>" bumper style threshold height
- Frame and panel corners are welded mitered joints
- All doors include corrosion resistant multi-point mortise lock system (complete with hardware)
- Multi-adjustable hinges
- Configurations X or XX

*NOTE: WinGuard® brand refers only to those products that are glazed with PGT® laminated glass.*

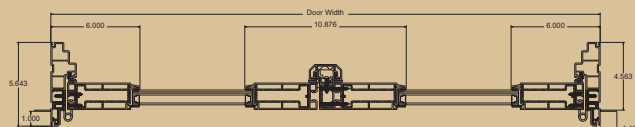
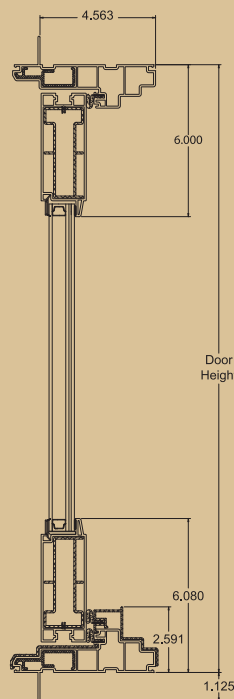













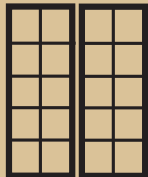
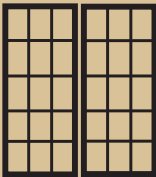



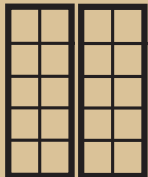

# SIZE CHART & STANDARD COLONIAL CONFIGURATIONS

## STANDARD

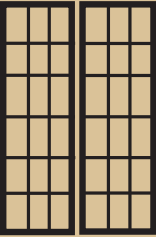
DOOR WIDTH (WITHOUT FIN)	30 <sup>1</sup> / <sub>4</sub>	32 <sup>1</sup> / <sub>4</sub>	36 <sup>1</sup> / <sub>4</sub>	59 <sup>1</sup> / <sub>2</sub>	63 <sup>1</sup> / <sub>2</sub>	71 <sup>1</sup> / <sub>2</sub>
MASONRY OPENING NO BUCK	30 <sup>1</sup> / <sub>2</sub>	32 <sup>1</sup> / <sub>2</sub>	36 <sup>1</sup> / <sub>2</sub>	59 <sup>3</sup> / <sub>4</sub>	63 <sup>3</sup> / <sub>4</sub>	71 <sup>3</sup> / <sub>4</sub>
MASONRY OPENING 1X BUCK	32	34	38	61 <sup>1</sup> / <sub>4</sub>	65 <sup>1</sup> / <sub>4</sub>	73 <sup>1</sup> / <sub>4</sub>
MASONRY OPENING 2X BUCK	33 <sup>1</sup> / <sub>2</sub>	35 <sup>1</sup> / <sub>2</sub>	39 <sup>1</sup> / <sub>2</sub>	62 <sup>3</sup> / <sub>4</sub>	66 <sup>3</sup> / <sub>4</sub>	74 <sup>3</sup> / <sub>4</sub>
WOOD FRAME OPENING	30 <sup>1</sup> / <sub>2</sub>	32 <sup>1</sup> / <sub>2</sub>	36 <sup>1</sup> / <sub>2</sub>	59 <sup>3</sup> / <sub>4</sub>	63 <sup>3</sup> / <sub>4</sub>	71 <sup>3</sup> / <sub>4</sub>

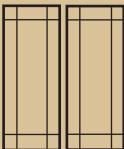
79 <sup>1</sup> / <sub>2</sub>	79 <sup>3</sup> / <sub>4</sub>	80 <sup>1</sup> / <sub>2</sub>	81 <sup>1</sup> / <sub>4</sub>	79 <sup>3</sup> / <sub>4</sub>						
					2668	2868	3068	5068	5468	6068
83 <sup>1</sup> / <sub>2</sub>	83 <sup>3</sup> / <sub>4</sub>	84 <sup>1</sup> / <sub>2</sub>	85 <sup>1</sup> / <sub>4</sub>	83 <sup>3</sup> / <sub>4</sub>						
					2670	2870	3070	5070	5470	6070
95 <sup>1</sup> / <sub>2</sub>	95 <sup>3</sup> / <sub>4</sub>	96 <sup>1</sup> / <sub>2</sub>	97 <sup>1</sup> / <sub>4</sub>	95 <sup>3</sup> / <sub>4</sub>						
					2680	2880	3080	5080	5480	6080
DOOR HEIGHT (WITHOUT FIN)	MASONRY OPENING NO BUCK	MASONRY OPENING 1X BUCK	MASONRY OPENING 2X BUCK	WINDOW FRAME OPENING						
									Prairie/Brittany (standard)	Prairie/Brittany (standard)

Note: Openings given assume a 1/8" shim space, maximum 1/4".

## DESIGN PRESSURE GUIDE

STYLE	TESTED PRESSURE	WATER-TESTED PRESSURE	TESTED SIZE	TYPE OF TEST	RATING
French Door	+50/-55 psf	10.5 psf	72" x 96"	ANSI/AAMA/WDMA 101/I.S.2/NAFS and ASTM E1886/E1996	HGD-C50



*Kitty Hawk Land Development;  
Kitty Hawk and Corolla, NC*

PGT® WinGuard® Impact-Resistant windows and doors are effortless, yet they meet the strictest codes in the nation. No wonder over 1.6 million units have been installed.



*"We were hit bad with in excess of 130 mile-an-hour winds from Hurricane Ivan. But thanks to PGT, our two living levels remained high and dry, and there was no need to spend days wrestling with shutters or plywood. Thanks again for manufacturing such a wonderful, life-saving product."*

Terry and Jim Taylor, homeowners, Navarre Beach, FL  
Hurricane Ivan

*"You can do all the laboratory tests you want, but does it work in the real world? The answer is, yes! My house is living testimonial to the fact that PGT WinGuard windows do work and that they're worry free."*

Nelson Leidel, homeowner, Punta Gorda, FL  
Hurricane Charley

*"My WinGuard windows and doors withstood the eye of Category 4 Hurricane Charley. I was also impressed with the customer service provided by PGT after the storm."*

Gustavo Herrera, homeowner, Port Charlotte, FL  
Hurricane Charley

*"Punta Gorda looked like a war zone but I had no worries because I knew that I had WinGuard."*

Nelson Leidel, homeowner, Punta Gorda, FL  
Hurricane Charley

*"90% of Grand Cayman was destroyed, but our home held up very well and the best news is that NONE of the windows broke!"*

George Crockett, homeowner, Grand Cayman Island  
Hurricane Ivan

*"All of the buildings in the resort had received a lot of damage but this building looked like it came through untouched. We attributed that to the new building codes that Florida has, along with the windows and roofing material that were used. We used PGT WinGuard windows and doors."*

Art Schuller, Benchmark General Contractors, Inc., Ft. Myers, FL  
Hurricane Charley





N. Venice, FL • Salisbury, NC  
[pgtindustries.com](http://pgtindustries.com)